

**Soft Served  
 Portofino Soft Ice Cream Dispenser, 2  
 flavours+1mix, electr.control&touch  
 panel, 500cones/h-gravity**

ITEM # \_\_\_\_\_

MODEL # \_\_\_\_\_

NAME # \_\_\_\_\_

SIS # \_\_\_\_\_

AIA # \_\_\_\_\_

**560074 (POR214DGA3PH)**

Soft ice cream dispenser with 2x12 l tank capacity and 1,95 l cylinder volume, 2 flavours + 1 mix, electrical control and touch screen panel, countertop, hourly production: 500 cones (75 gr), gravity version, R452A

### Short Form Specification

**Item No.** \_\_\_\_\_

Soft ice cream and frozen yogurt dispenser with 2x12 l tank capacity and 1,95 l cylinder volume, 2 flavours + 1 mix, hourly production: 500 cones (75 gr). Digital control and touch screen panel. It is a countertop appliance with gravity system. The tank agitator and the stainless steel drip tray are included as standard. R452a as refrigerant gas. Air-cooled version: requires no water connections that means less operating costs and it is easy to install.

### Main Features

- The machine is equipped with tank agitator and stainless steel drip tray.
- Digital control with touch screen.
- It delivers soft ice cream and frozen yogurt.
- The machine is equipped with two tanks of 12 liters capacity and dispenses 500 cones/h (75gr cones).
- The gravity machine is extremely easy to use, clean and maintain. Ice cream has a strong and very intense flavor.
- Countertop appliance with gravity system delivers soft ice cream and frozen yogurt, two-flavor equipment.

### Construction

- Environmentally friendly: R452a as refrigerant gas.
- Air-cooled version requires no water connections that means low operating costs and easy installation.

**APPROVAL:** \_\_\_\_\_



**Electrolux**  
PROFESSIONAL

Soft Served  
Portofino Soft Ice Cream Dispenser, 2  
flavours+1mix, electr.control&touch panel,  
500cones/h-gravity

Front

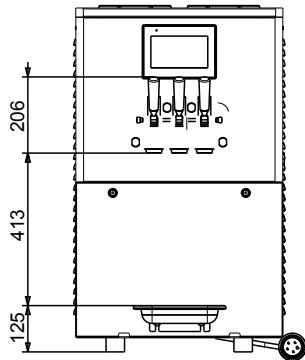

Side

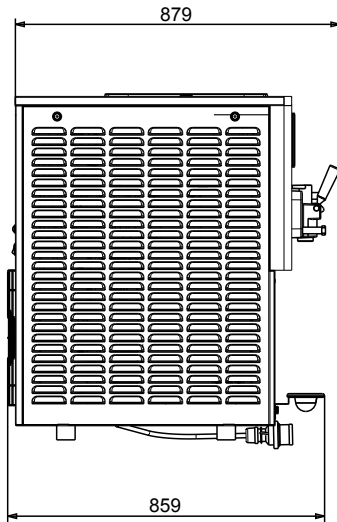

Top

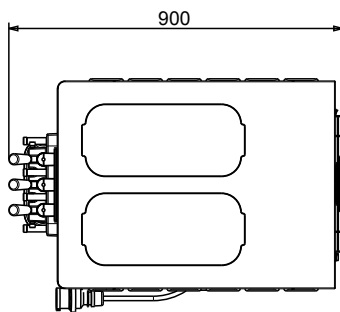

### Electric

Supply voltage:

560074 (POR214DGA3PH) 380-400 V/3N ph/50 Hz

Electrical power max.:

4.5 kW

### Key Information:

External dimensions, Width: 572 mm

External dimensions, Depth: 875 mm

External dimensions, Height: 931 mm

Net weight: 201 kg

Freezing cylinder capacity: 1.95 l

Preparation system: Gravity

N° of hoppers/grinders: 2

Hopper capacity: 12 l

Plug type: IEC/EN 60309-1/2

### Refrigeration Data

Operating temperature min.: 20 °C

Operating temperature max.: 40 °C

### Sustainability

Refrigerant type: R452A

Refrigerant weight: 1100 g



Soft Served  
Portofino Soft Ice Cream Dispenser, 2 flavours+1mix, electr.  
control&touch panel, 500cones/h-gravity  
The company reserves the right to make modifications to the products  
without prior notice. All information correct at time of printing.

2024.09.15